



DESIGNED BY	G. THAKURIA
CHECKED BY	S. P. C. Jhankumar (Eng. Design)
APPROVED BY	H. A. Saha (D.O. Eng. Design)
DATE	20/07/2020
DRAWN No	DR-LS/01

Legend	
—	Existing Ground Level
- - -	Existing Invert Level
—	Proposed Drain

DRAWING TITLE : LS/01

PROJECT : REPAIRING DRAIN SYSTEM AT SANTHIAGO MAWATHA (RIGHT SIDE).

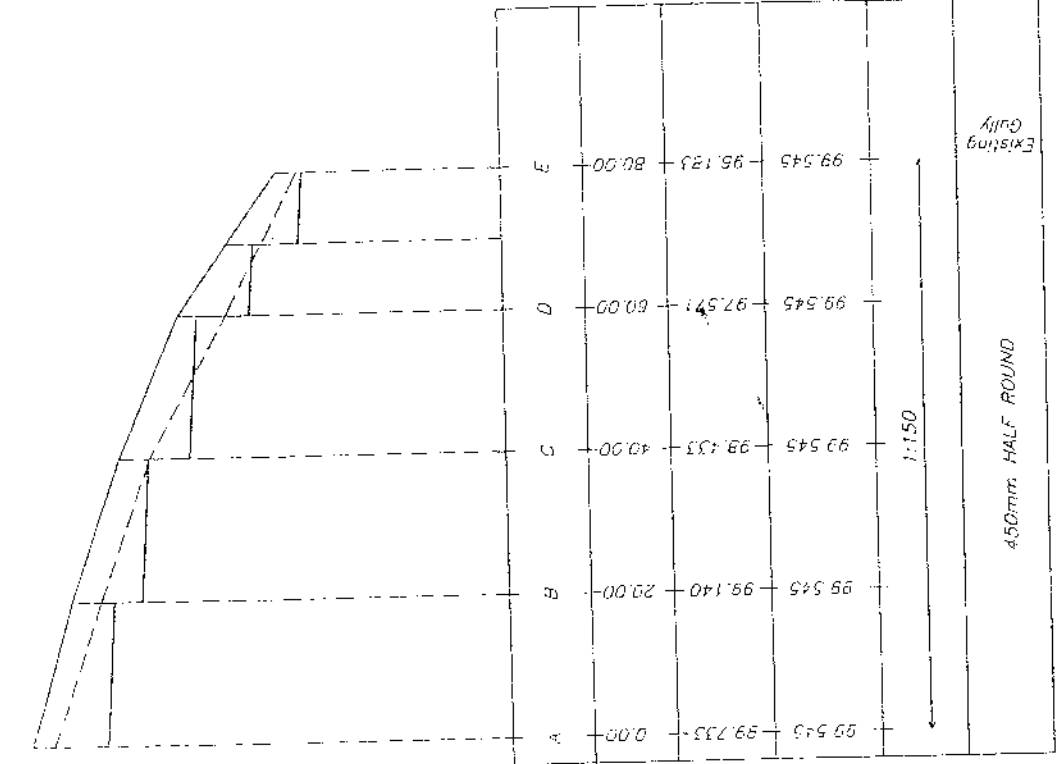

DATUM 93.00
100.0
99.0
98.0
97.0
96.0
95.0
94.0

POINT	
DISTANCE (m)	
GROUND LEVEL (m)	
INVERT LEVEL (m)	
SLOPE	
DRAIN DETAIL	

A	0.00	99.545	99.733	450mm HALF ROUND
B	20.00	99.545	99.140	1:150
C	40.00	99.545	98.433	
D	60.00	99.545	97.571	
E	80.00	99.545	96.123	
Existing Gully				

**ORIGINAL**

Scale  
1:100

100.0  
99.0  
98.0  
97.0  
96.0  
95.0  
94.0

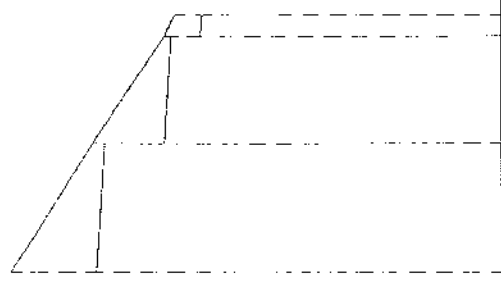

DATUM 93.00

POINT	DISTANCE (m)	GROUND LEVEL (m)	INVERT LEVEL (m)	SLOPE	DRAIN DETAIL
P	0.00	98.845	98.845		EXISTING
Q	18.00	98.700	98.700		PROPOSED
R	36.00	97.555	97.555		EXISTING
S	36.00	97.700	97.700		PROPOSED
		97.555	97.555		EXISTING
		97.700	97.700		PROPOSED
		97.845	97.845		EXISTING

DESIGNED BY	G. Thambila S.P. C. Illakkumar (Eng. Designer)
CHECKED BY	M.A. Sana (S.D. Eng. Designer)
APPROVED BY	M.L.M. Suresh (Chief Engineer)
DATE	20/11/2020
DRAWN No	DR-LS-02

Legend	Existing Ground Level
	Existing Invert Level
	Proposed Drain

DRAWING TITLE : LS 102

PROJECT : REPAIRING DRAIN SYSTEM AT SATHIAGO MAWATHA (LEFT SIDE).

MIT 29

**ORIGINAL**

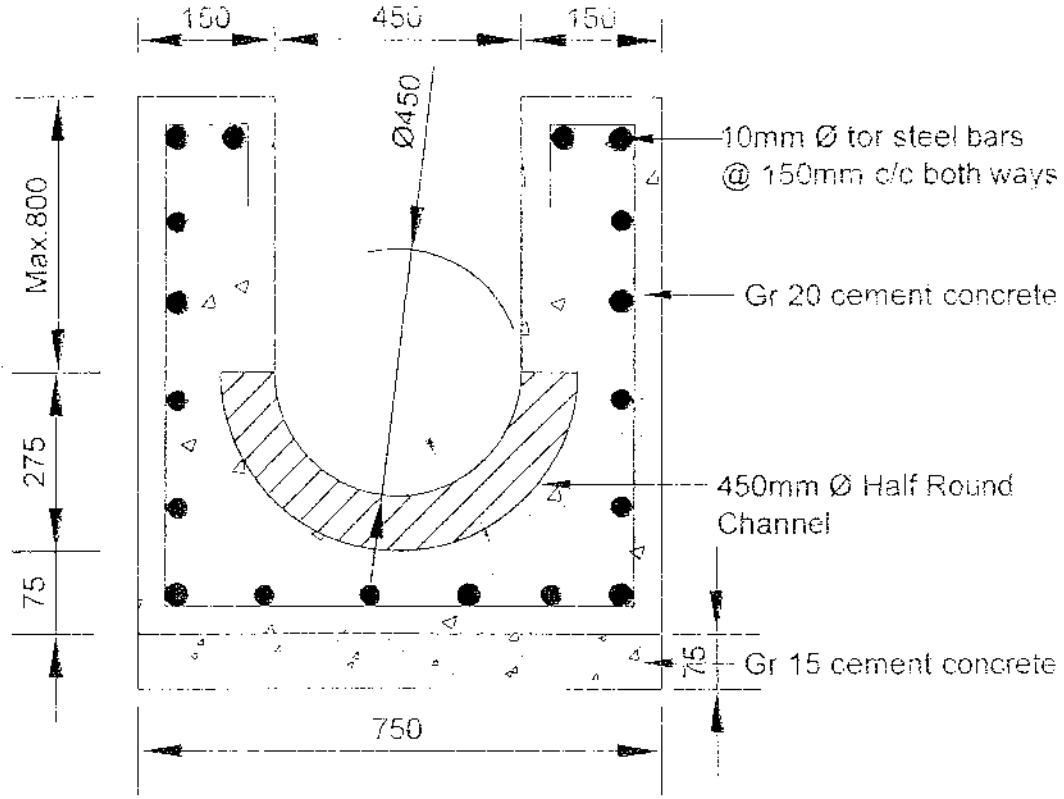

## SECTION OF HALF ROUND CHANNEL

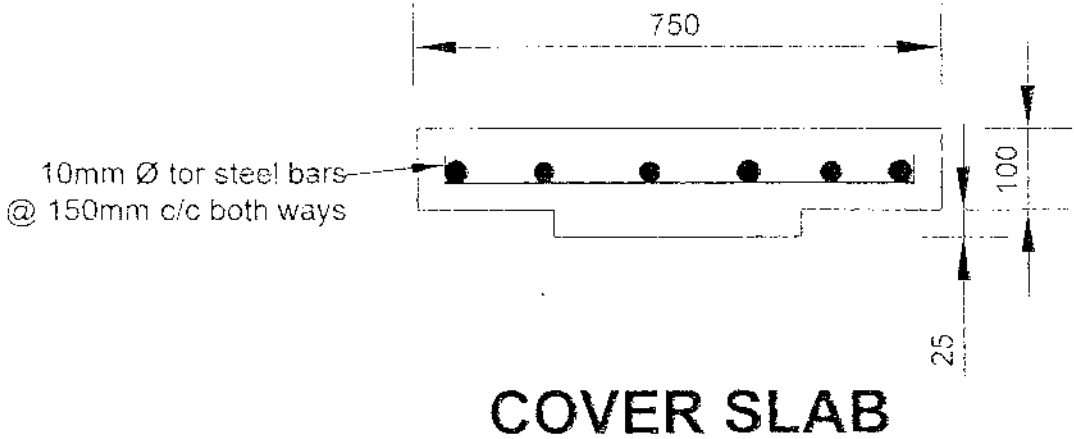

NOTE  
ALL DIMENSIONS ARE IN MILLIMETERS

## HALF ROUND CHANNEL WITH COVER SLAB

(Drawing - A)

ORIGINAL

3/21/20

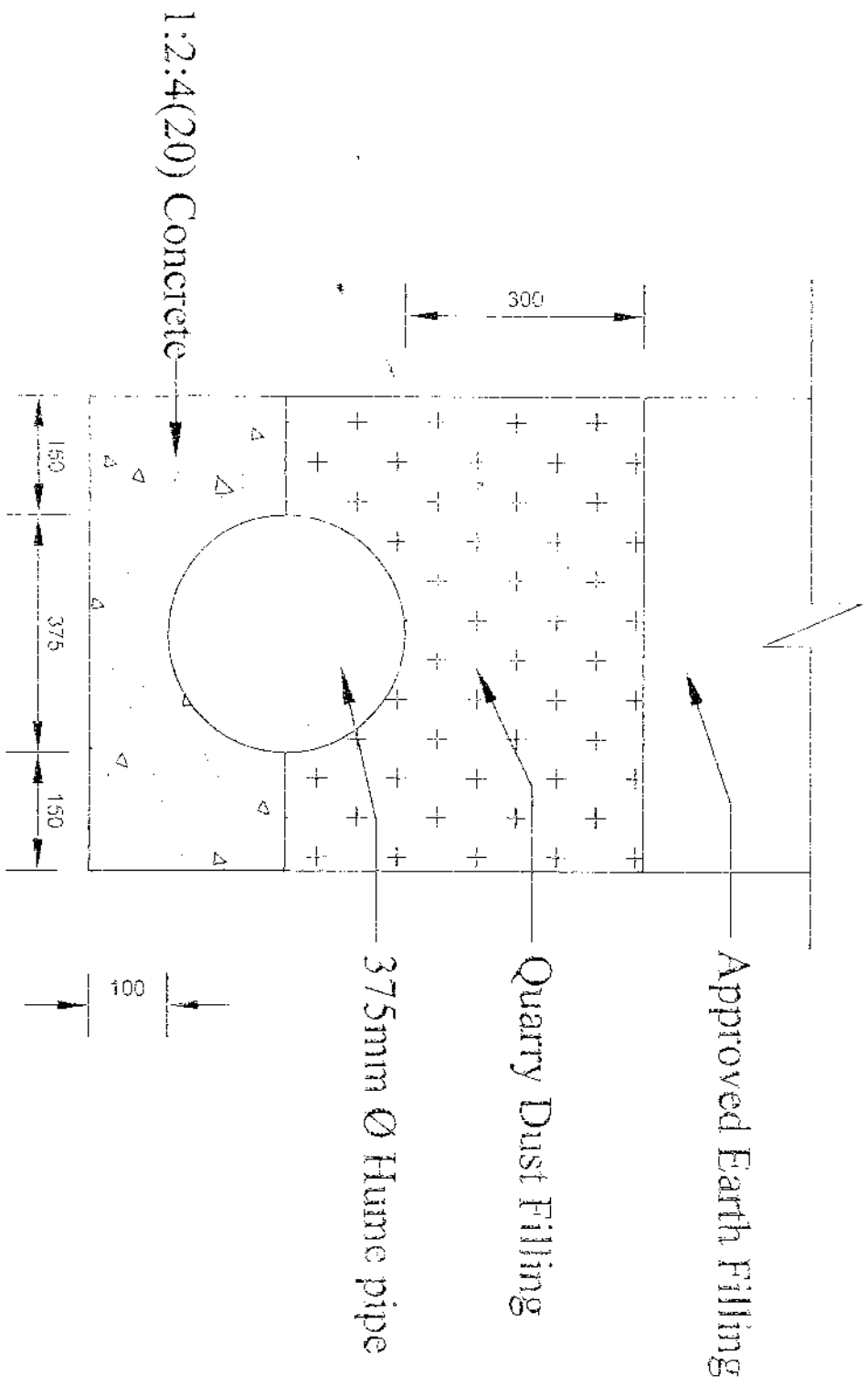

DETAIL OF BED & HAUNCHING AND FILLING

ALL DIMENSIONS ARE IN mm

DRAWING TITLE : DETAIL OF BED & HAUNCHING - 375 mm HUME PIPE

C Drawing 83

DRAWING TITLE : RAIN WATER GULLY  
500 X 500mm

NOTE  
ALL DIMENSIONS ARE IN MILLIMETERS

PLAN VIEW

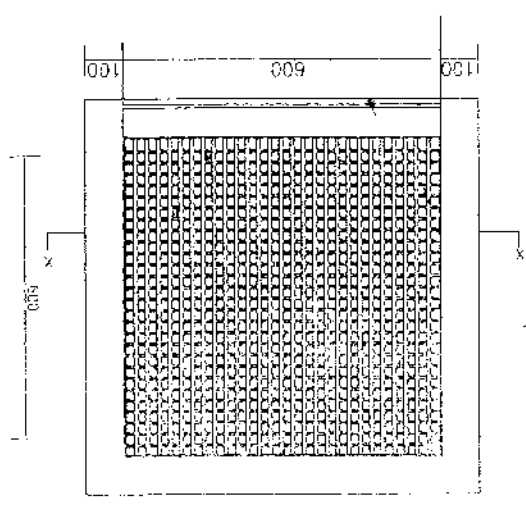

SECTION X-X

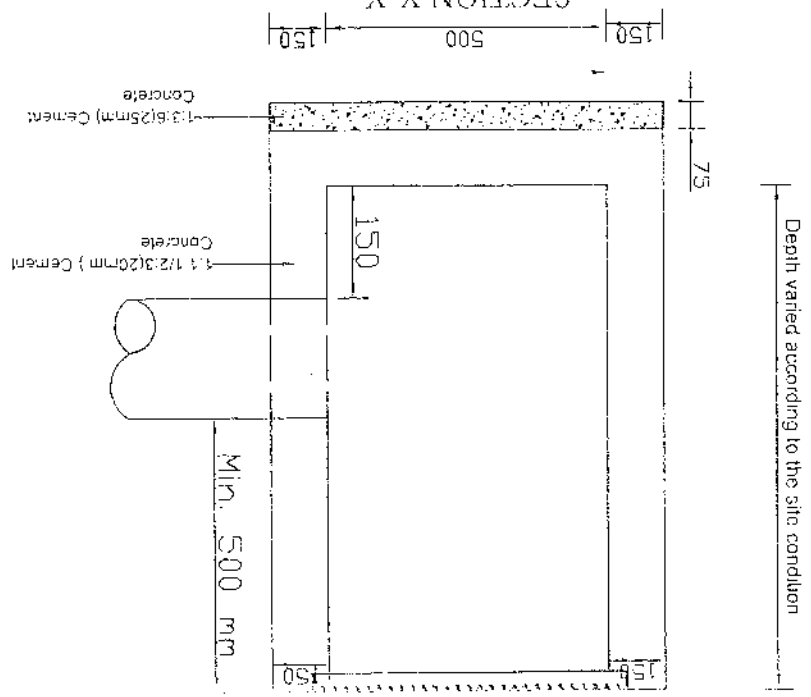

ORIGINAL

**SECTION 9**  
**STANDARD FORMS (BID)**

**Note:**

It is the responsibility of bidders to comply with all the requirements given in the bidding document. Failure to non compliance with any of the may be a reason for rejection of the bid.

**Notes on Standard Forms:**

- Bidders shall submit the completed form of bid security/Bid Securing Declaration as appropriate in compliance with the requirements of the bidding documents.
- Bidders should not complete the Form of Agreement at the time of preparation of bids.
- The successful bidder will be required to sign the Form of Agreement, after the award of contract.
- Any corrections or modifications to the accepted bid resulting from arithmetic corrections, acceptable deviations, or quantity variations in accordance with the requirements of the bidding documents should be incorporated into the Agreement.
- The Form of Performance security, Form of Advance Payment Security and Form of Retention Money Guarantee should not be completed by the bidders at the time of submission of bids.
- The successful bidder will be required to provide these securities in compliance with the requirements herein or as acceptable to the Employer.

**FORM OF BID SECURITY**

----- [ insert issuing agency's name, and address of issuing branch or office]

**Beneficiary :Municipal Commissioner, Colombo Municipal Council, Town Hall, Colombo 7**

**Date :**----- [ insert (by issuing agency) date]

**BID GUARANTEE No:** ----- insert (by issuing agency number]

We have been informed that ----- [insert (by issuing agency) name of the Bidder] (hereinafter called "the Bidder") has submitted to you its bid dated ----- ] insert (by issuing agency) date] (hereinafter called "the Bid") for improvements to ----- (insert name of contract)for Bids No. ----- (insert reference number of the bid).

Furthermore, we understand that, according to your conditions, Bids must be supported by a Bid Guarantee.

At the request of the Bidder, we ----- [insert name of issuing agency] hereby irrevocably undertake to pay you any sum or sums not exceeding in total an amount of ----- [insert amount in figures] ----- [ insert amount on words] upon receipt by us of your first demand in writing accompanied by a written statement stating that the Bidder is in breach of its obligation(s) under the bid conditions, because the Bidder:

- a) Has withdrawn its Bid during the period of bid validity specified; or
- b) Does not accept the correction of errors in accordance with the instructions to Bidders ~~(hereinafter "the ITB"); or~~
- c) Having been notified of the acceptance of its Bid by the Employer during the period of bid validity, (i) fails or refuses to execute the contract Form, if required, or (ii) fails or refuses to furnish the Performance Security , in accordance with the ITB.

This Guarantee shall expire: (a) if the Bidder is the successful bidder, upon our receipt of copies of the Contract signed by the Bidder and of the Performance Security issued to you by the Bidder: or (b) if the Bidder is not the successful bidder, upon the earlier of the successful bidder furnishing the performance security, otherwise it will remain in force up to -----

Consequently, any demand for payment under this Guarantee must be received by us at the office on or before that date.

----- [ signature(s) and name(s) of authorized representative(s)] -----



**ORIGINAL**

**SECTION 10**  
**Other documents**



සමාගම් රෙජිස්ට්‍රාර් දෙපාර්තමේන්තුව  
 கம்பனிகள் பதிவுகாங்குத் திணைக்களம்  
 DEPARTMENT OF THE REGISTRAR OF COMPANIES

'කොමර් මියුර්'  
 400, රි.ආ.වී. විජේවර්ධන මාවත,  
 කොළඹ 10.  
 'கம்பனி கிழவர'  
 400, ඊ.ඒ. ඩබ්ලිව්වර්ධන මාවත,  
 කොළඹ 10.  
 'SAMBAMMEDURA'  
 400, D.R. Wijewardena Mawatha,  
 Colombo 10.  
 Email : registrar@slnc.gov.lk  
 Web Site : www.slnc.gov.lk

දුරකථන අංකය  
 Telephone No  
 2689287  
 2689288  
 'රෙජිස්ට්‍රාර් වෙබ් අඩවිය' 'Registry Website'  
 www.slnc.gov.lk  
 1502  
 ලේකම් කුමාරතුංග පී.ආ. අබේ  
 P.O. Box  
 2689291  
 ලේකම් කුමාරතුංග පී.ආ. අබේ  
 P.O. Box

මගේ අංකය  
 My No. | PCA / 13278  
 ඔබේ අංකය  
 Your No.

දිනය  
 Date | 2013-09-02

J.M හේනරි ජයවර්ධන මිය  
 කාර්මික කොමසාරිස්  
 කොළඹ මහනගර සභාව  
 කොළඹ 07

ORIGINAL

පොදු කොන්ත්‍රාත් ගිවිසුම් ලියාපදිංචි කිරීම.

1987 අංක 3 දරණ පොදු කොන්ත්‍රාත් ගිවිසුම් පණතේ 8 වන වගන්තිය අනුව කොන්ත්‍රාත් විවරය මිලිපත 05 ඉක්මවන විට වෙන්විඳිකරු හෝ වෙන්විඳිකරු සඳහා හෝ වෙනුවෙන් කටයුතු කරන අනුයෝජිතයකු , උප අනුයෝජිතයකු , නියෝජිතයකු හෝ කාර්යාලයකු ලෙස ආකෘති පත්‍ර 1 මගින් ලියාපදිංචි විය යුතුය.

එසේම එම වෙන්විඳිකරු ප්‍රධාන සේවකයෙකු වශයෙන් දැක්වීමට සූදානම් වී පවතින විට වෙන්විඳිකරු ප්‍රධාන සේවකයෙකු ලෙස දින 60 ක් ඇතුළත ආකෘති පත්‍ර 2 මගින් අදාළ කොන්ත්‍රාත් පොදු කොන්ත්‍රාත් රෙජිස්ට්‍රාර්වරයා වෙත ඉදිරිපත් කළ යුතු අතර එසේ නොකිරීම පණතේ 9 (1) වගන්තිය අනුව දඬුවම් ලැබිය හැකි වරදකි.

2013/08/01 ර දිනැති ඔබගේ ප්‍රවෘත්ති දැන්වීමට අනුව 2013/09/02/2013 දරණ වෙන්විඳිකරු සඳහා අදාළව 01 ක් වෙම රෙජිස්ට්‍රාර්වරයා වෙත ලැබී ඇති අතර , ඒ සඳහා බලපත්‍රය නිකුත් කර ඇත. එබැවින් වෙන්විඳිකරු ප්‍රධාන සේවකයෙකු ලෙස දින 60 ක් ඇතුළත ආකෘති පත්‍ර 2 මගින් වෙන්විඳිකරු ප්‍රධාන සේවකයෙකු ලෙස දින 60 ක් තුළ ආකෘති පත්‍ර 2 මගින් ලියාපදිංචි විය යුතු බවට වන වගන්තිවලට අවධානය යොමු කර ගත යුතුය.

M  
 පොදු කොන්ත්‍රාත් රෙජිස්ට්‍රාර් වෙනුවෙන්